



**Barbour Plastics, Inc.**

Extruded Rigid & Flexible  
PVC Mouldings  
& Trim Profiles



This brochure represents a collection of over 150 of the most commonly ordered rigid and flexible Barbour mouldings. Applications for these extruded thermoplastic profiles vary from table edge trim, carpet trim and corner guards to product display bumper mouldings and wall mount protection systems. Profiles are shown at actual size.

Barbour mouldings can be:

- ❖ Matched to your color specifications or selected from over 150 stock colors.
- ❖ Made from interior or exterior grade PVC.
- ❖ Extruded with a low or high gloss level.
- ❖ Applied with double sided adhesive tape (PSA or VHB).
- ❖ Cut to length, punched, drilled or heat formed to your specific application.
- ❖ Matching end caps and splice caps are available for some profiles. Call for details.

### Custom mouldings

Barbour Plastics has custom profile capabilities to meet your specific requirements. Our in-house tool and die shop allows us to complete customized tooling both efficiently and at extremely competitive prices. Call us at (508)583-8200 to discuss your specific needs.

Color key to mouldings

R = Rigid



F = Flexible



## Flat Trim Mouldings

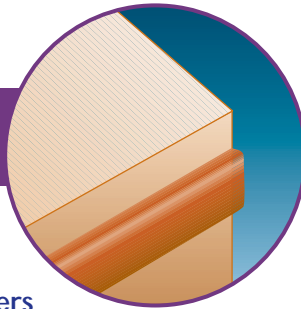

Barbour's rigid flat trim mouldings succeed in accomplishing the most basic of needs in trim application. Always of high quality, our flat trim mouldings provide the answer to those seeking an economical solution.

### Applications

- Wall bumper
- Decorative trim
- Protective bumpers
- Wear strips
- Strike plates



R1293



R1230



R1086



R1154



R1187



R645



R1220



R1146



R1232



R1224



R1020

## Applications

- Carpet edging
- Product trim
- Safety bumpers
- Wall rails
- Display bumpers

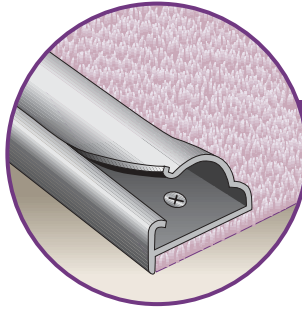

# Bumper Moulding & Trim Profiles

One piece flexible trim mouldings have self-contained flaps that cover the fasteners.



Our economical, flexible solid profiles with a centerline screw groove are easy to install.

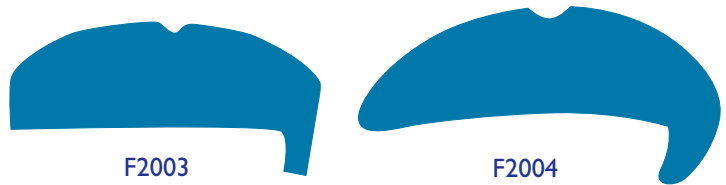

Two piece units are great for decorative bumper mouldings or for finishing trim while hiding screw heads. Two piece flexible units are ideal for radius bends and maximum impact.

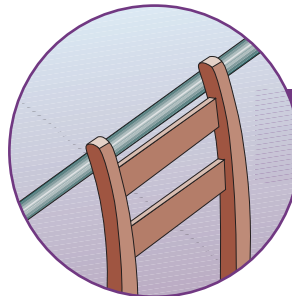
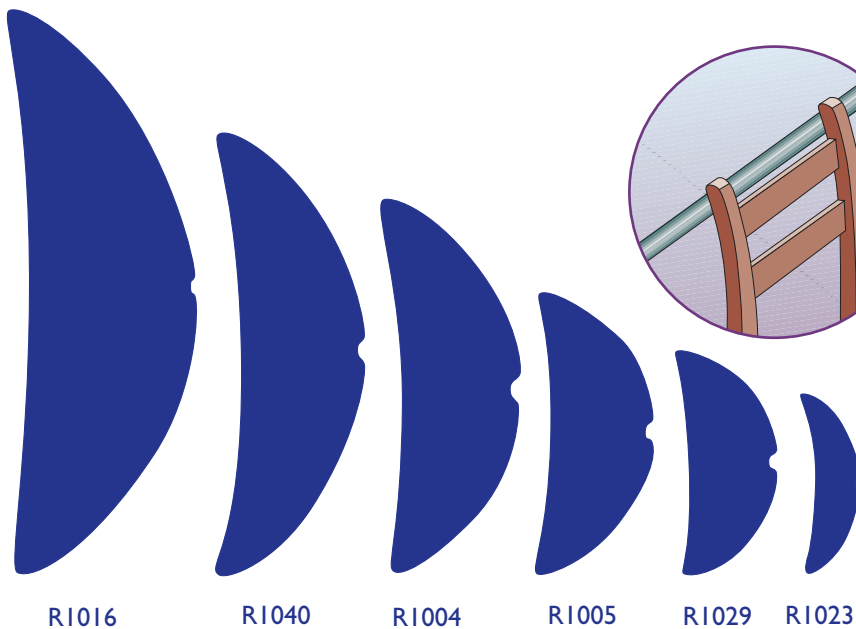
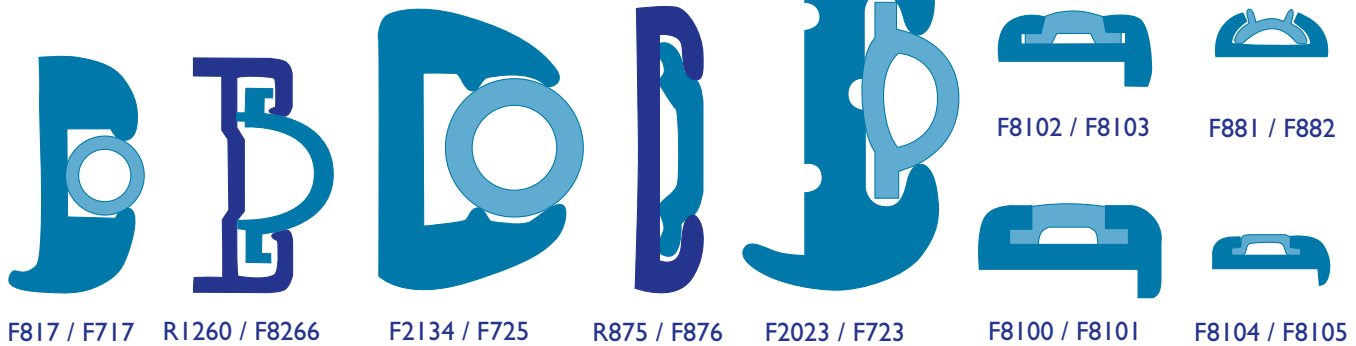

## Half Ovals

- Applications**
- Wall rails
  - Equipment bumpers
  - Wear strip
  - Strike plates

Barbour's half ovals are made of the highest quality rigid plastic available. Beautifully constructed, Barbour half ovals provide the ultimate in design in a variety of colors and lengths.

# U Mouldings

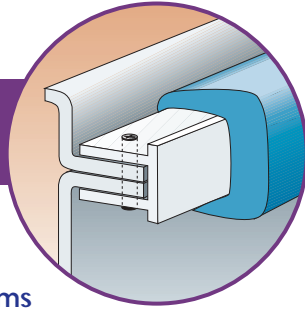

U mouldings can be used in combination: a rigid U Moulding piece inside and a flexible exterior piece which covers the fasteners.

## Applications

- Finish rough edges
- Joining deck and hull seams
- Caps
- Sharp edge protector
- Banner frame



F8405

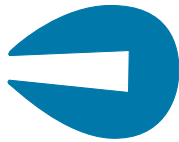

F2170



F2038

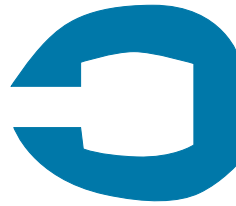

F2058

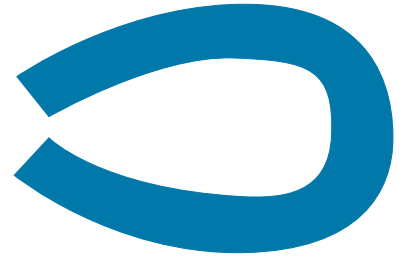

F2040



F8238



F815



F810

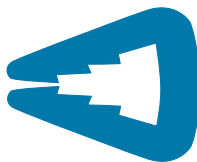

F2131

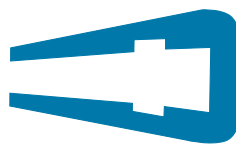

F893

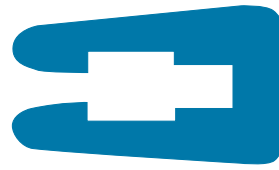

F859

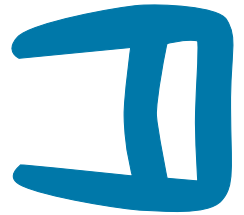

F2139



F2215



F864 / R1064



F843 / R840



F867 / R1063



F2026 / R1026



R1270



R1039



R673



R654

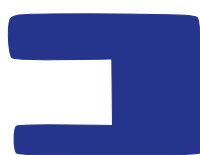

R1012



R1035



R1181



R662

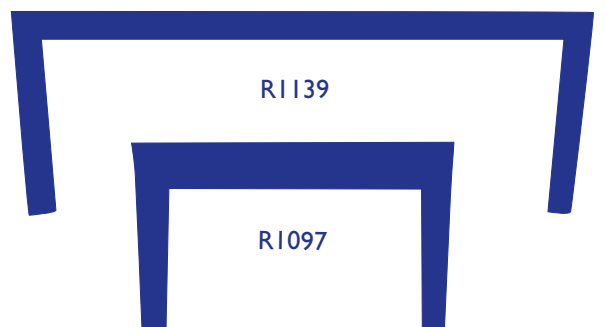

R1139

R1097

Barbour's superbly crafted L mouldings are an outstanding way to trim off raw edges.

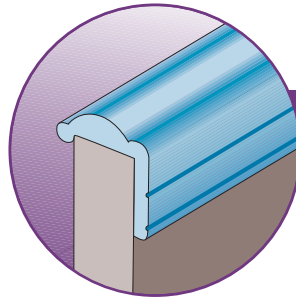

## L Mouldings

### Applications

- Finish rough edges
- Counter top edging
- Corner guards
- Track guides
- Wall / floor anchor
- Edge trim
- Shelf dividers

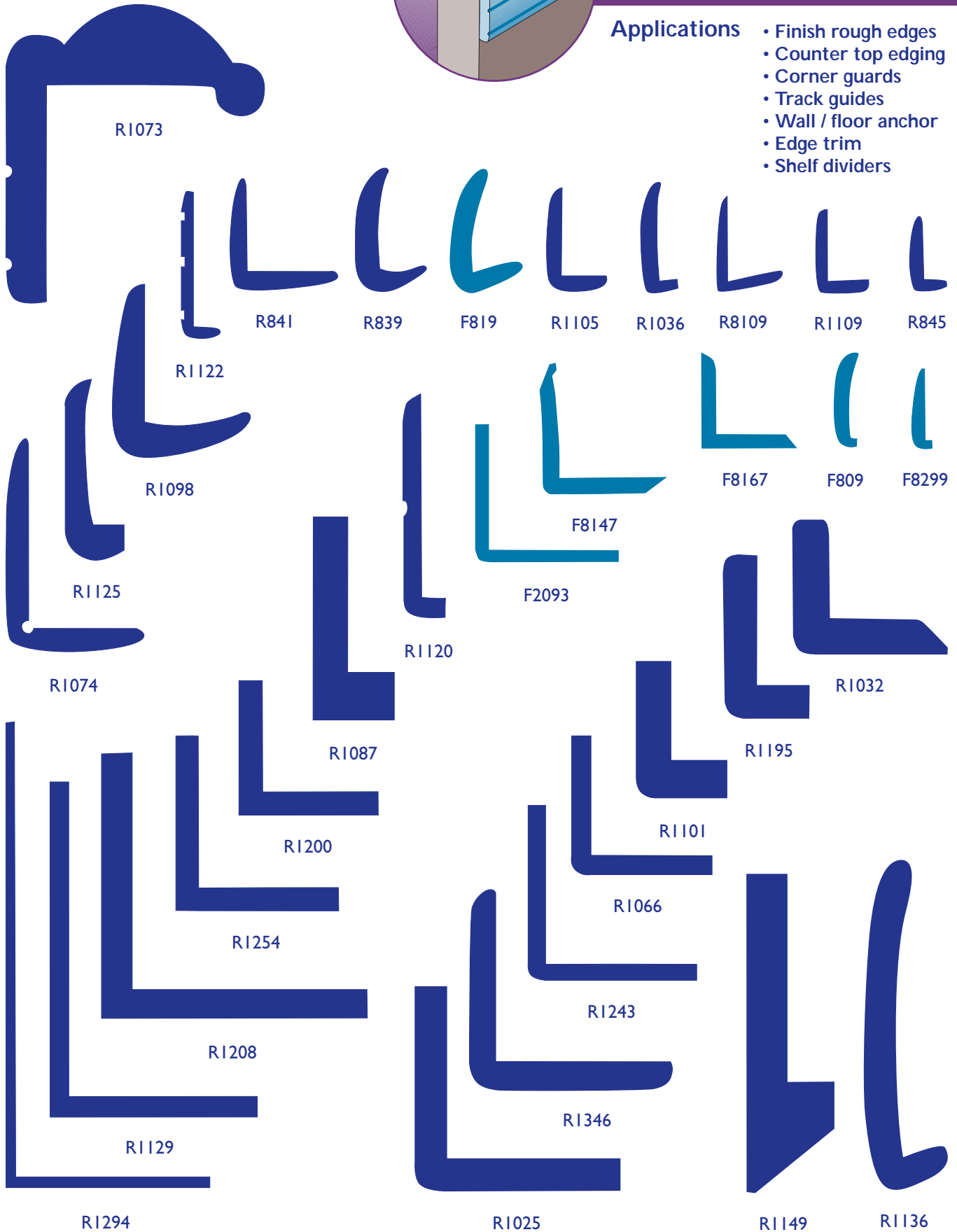

## Table Edge & Interior Trim

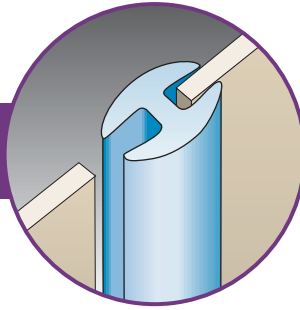

Barbour's table edge and interior trim are perfect for joining panel seams or trimming off wall and table edges, often eliminating the need for time consuming gluing. The flexibility of these pieces allow them to bend and contour to desired applications.

### Applications

- Bathroom wall panel edging
- Table and counter edging
- Furniture edge trim
- Joint seams



F2111



F2148

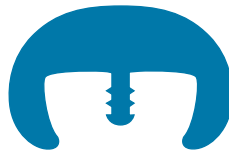

F8368

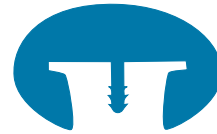

F2084

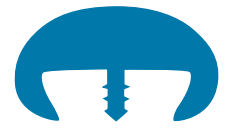

F2222



F8354



F8115

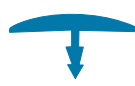

F8246



F8274



F8237



F8241

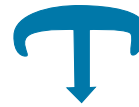

F8173



F8369



F8282

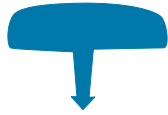

F8171



F8314



F8169



F8259



F8301

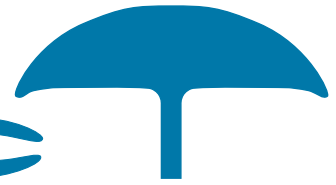

F2236

## One Piece Trim Units

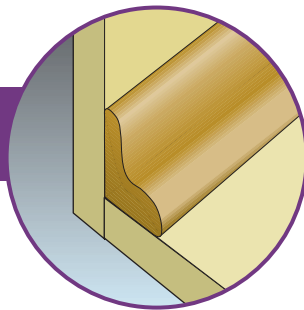

Barbour's one piece trim units with self-adhesive backings ease installation dramatically. The self adhesive backing makes these trim units easy to handle, and aids in the overall application procedure. All items are available with either PSA or VHB Tape.

### Applications

- Joint seams
- Carpet edging
- Gasketing
- Bumpers
- Edge trim

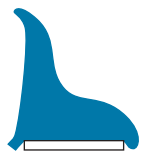

F8353 (Tape)



F8359 (Tape)



F8146 (Tape)



F8332 (Tape)



F8304 (Tape)



F8275 (Tape)



F8108 (Tape)



F895 (Tape)



F8254 (Tape)



F8252 (Tape)

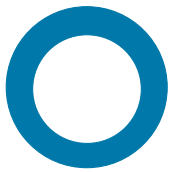

F761



R1047

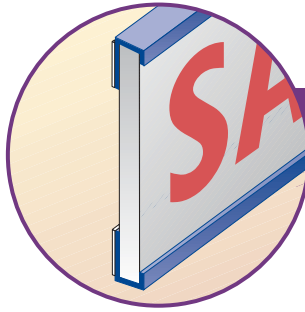

# Miscellaneous Extrusions

## Applications

- Welting
- Ladder treads
- Door tracks
- Panel joiners
- Sign holders



R1203



R669



F721



F768



F728

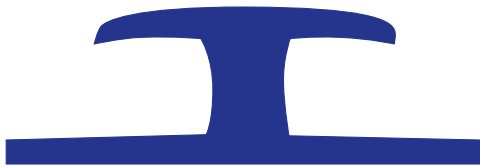

R1295

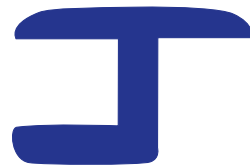

R1144

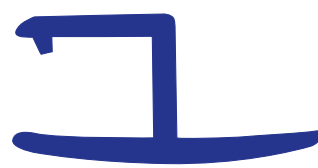

R1258



R1128



R1316



F8182

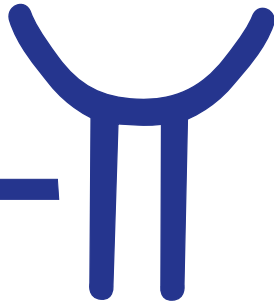

R1332



R1361



R1138



R1173



F8239



R8132



F712



R1213

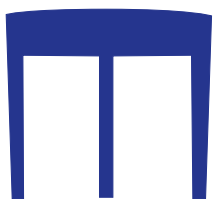

R1194

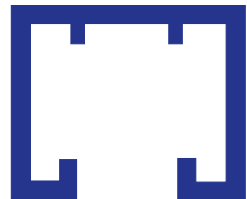

R1116

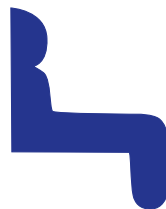

R1245

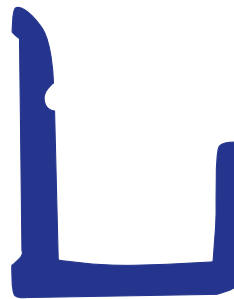

R1071

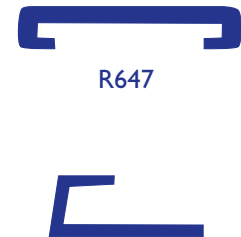

R647



R844



R649



R648



R653



R658



R659



R1290



R1291

R724